

ITEM	QTY.	DESCRIPTION	PART NUMBER					BP	BN	BV	FB	PR	RN	RB	DP
			1 inch	2 inch	3 inch	4 inch	6 inch								
1	1	Washer	4543		4491			X	X	X	X	X	X	X	X
2	1	Thread Seal	4542		4488			X	X	X	X	X	X	X	X
3	1	O-Ring			155			X	X	X	X	X	X	X	X
4	6	Filter Screen			619			X	X	X	X	X	X	X	X
5	1	Pilot Plug	3017		112			X	X	X	X	X	X	X	X
6	1	Gasket Pilot Seat	3018		118			X	X	X	X	X	X	X	X
7	1	Pilot Seat	3016		113			X	X	X	X	X	X	X	X
8	1	Diaphragm Stabilizing	3014		110			X	X	X	X	X	X	X	X
9	1	Pilot Seat	3015		565			X	X	X	X	X	X	X	X
10	1	Spacer Ring	----		7437			X	X	X	X	X	X	X	X
11	1	Diaphragm	3011P		5259P			X	X		X	X	X	X	X
12	1	Spring Helical Conical	3008		108			X		X	X	X		X	X
	1	Spring	3008		585				X				X		
13	1	Diaphragm Stabilizing	3014		6520									X	
14	1	Gasket Bonnet	4554		276									X	
15	1	Spring Booster (Ductile only)	----		566					X					
16	1	Diaphragm (Ductile only)	3011P		688					X					
17	1	Diaphragm	127	1706	1640	2015	2140	X	X	X	X	X	X	X	X
18	1	Gasket Body	195	196	197	198	199	X	X	X	X	X	X	X	X
19	2	Back Up	148T	149T	150T	151T	152T	X	X		X	X	X	X	X
20	1	O-Ring	153	154	155	156	157	X	X		X	X	X	X	X
21	1	Seat Full Port	163	164	165	166	167	X	X	X	X	X	X	X	X
		Seat Reduced Port	163	164	1230	164	165	X	X	X	X	X	X	X	X
22	1	Gasket Removable Seat	----	276	277	196	279	X	X	X	X	X	X	X	X
23	1	Nut Full Port	172	173	906	175		X	X	X	X	X	X	X	X
		Nut Reduced Port	172	173	173	906		X	X	X	X	X	X	X	X
24	1	O-Ring (Steel only)	----	5225	5226	5227	4086	X	X	X	X	X	X	X	X

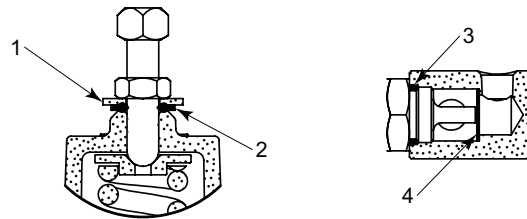

**BP, BN, DP**

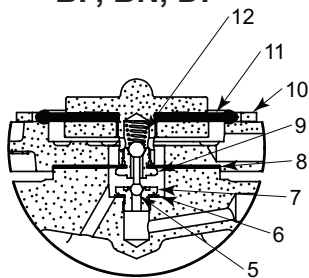

**PR, RN, FB**

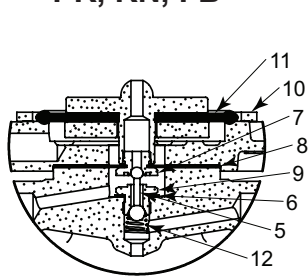

**RB**

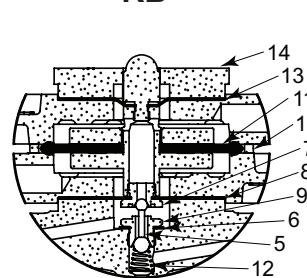

**BV**

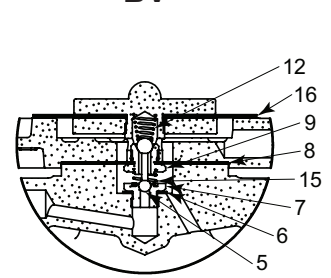

Please note the Pilot Plug (7) and Spring (12) orientation

**Ductile**

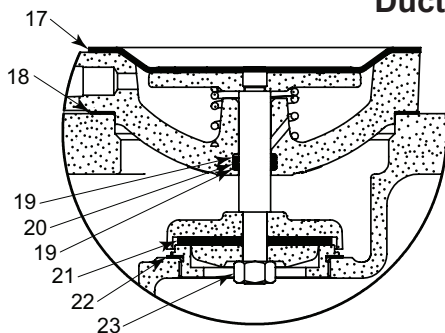

**Steel**

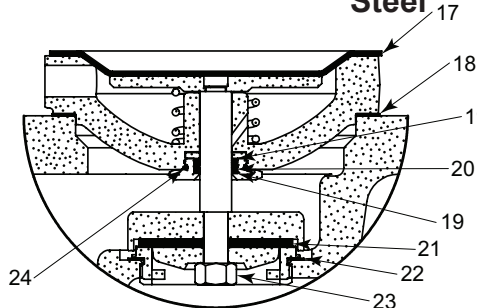

All Pictures shown are for illustration purpose only. Actual product may vary due to product enhancement.

For additional information & documentation visit [www.kimray.com](http://www.kimray.com)

# PRESSURE REGULATORS



## REPAIR KIT 6 INCH HIGH PRESSURE REGULATORS

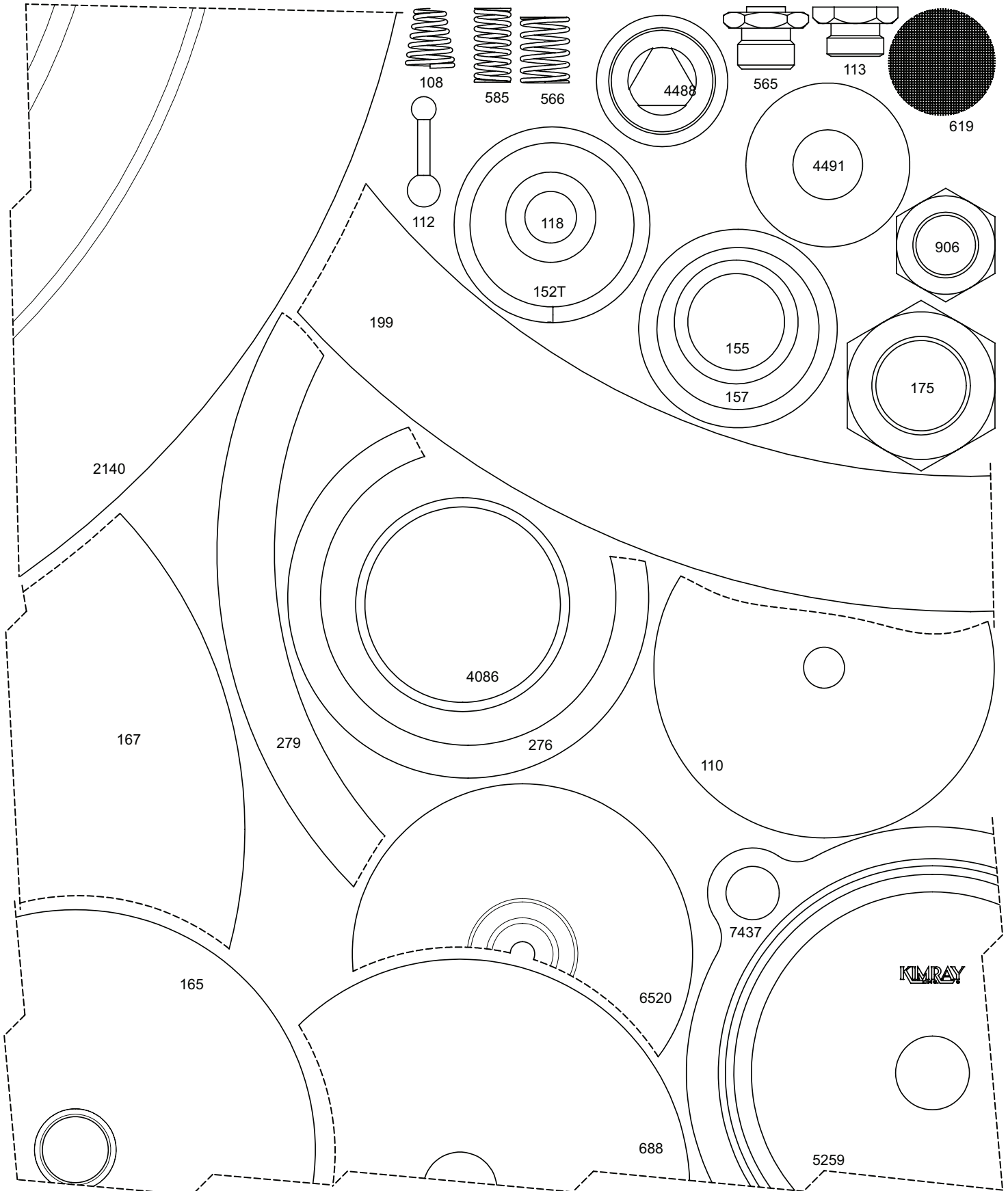

All Pictures shown are for illustration purpose only. Actual product may vary due to product enhancement.