

ITEM	QTY.	DESCRIPTION	1 INCH	2 INCH
1	1	O Ring	155	157
2	1	O Ring	156	520
3	4	Packing Ring	484	533
4	1	Packing Sleeve	485	534
5	2	Felt Wiper	480	527
6	2	Snap Ring	938	940
7	2	O Ring	491	537
8	1	O Ring	153	530
9	1	O Ring	2881	-----

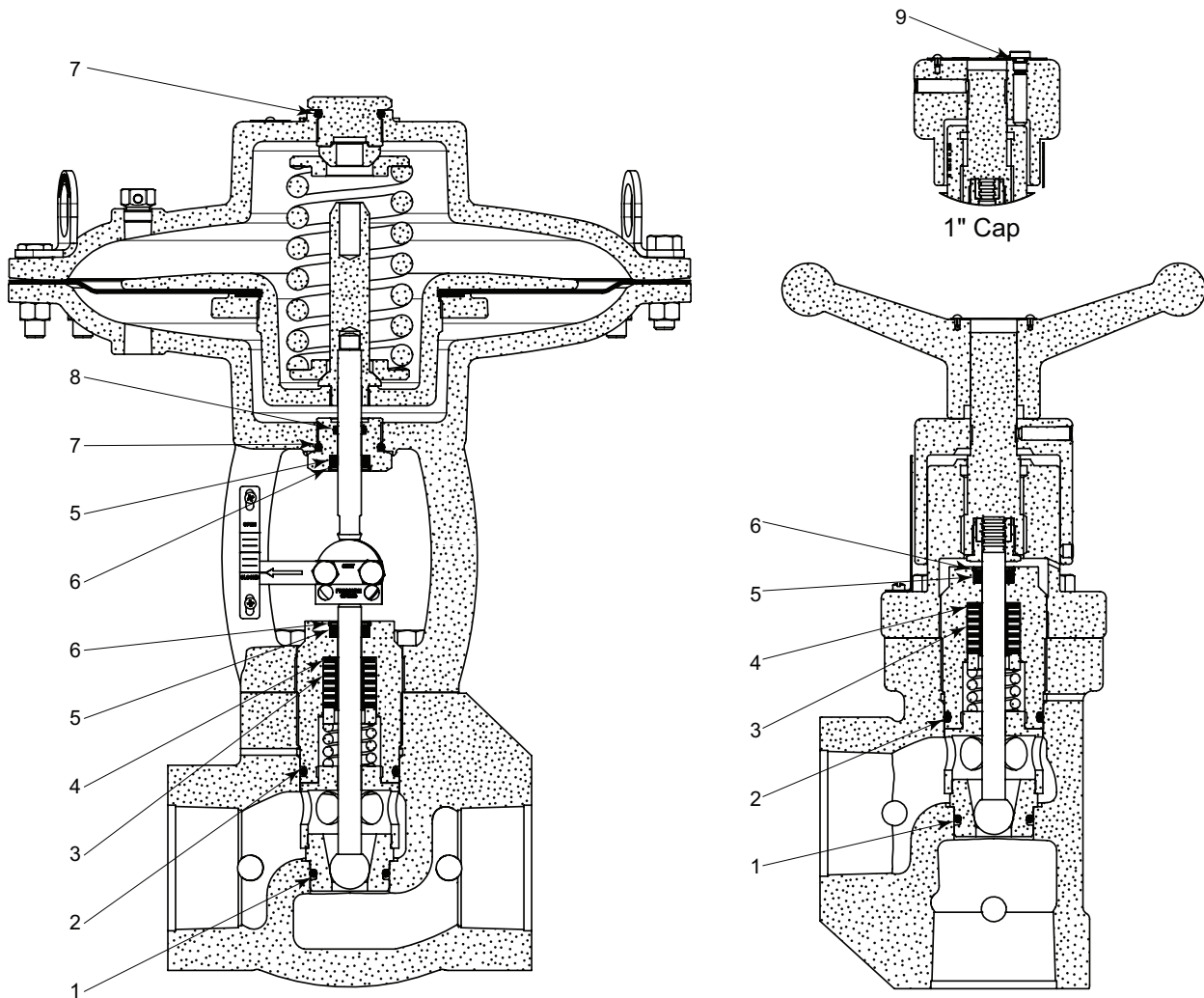

HIGH PRESSURE CONTROL VALVES

REPAIR KIT
STEM GUIDED



153

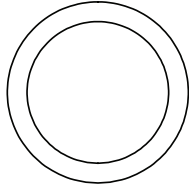

155

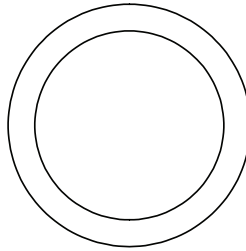

156

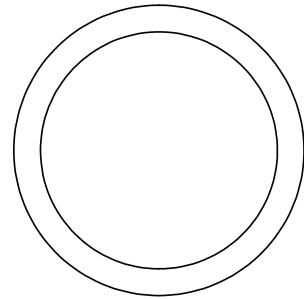

157

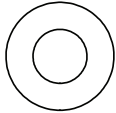

480

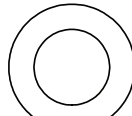

484

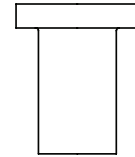

485

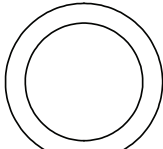

491

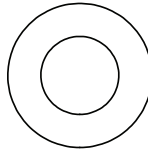

527

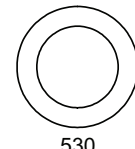

530

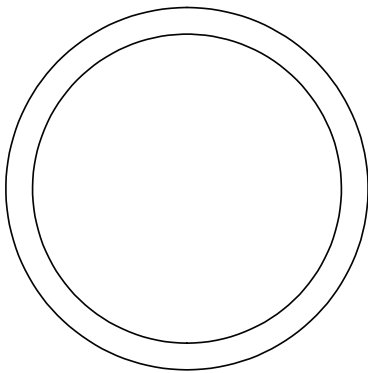

520

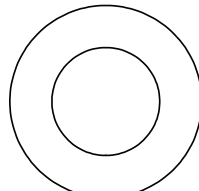

533

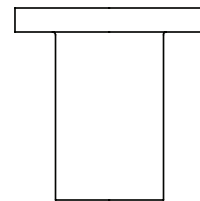

534

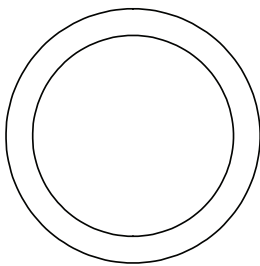

537



2881

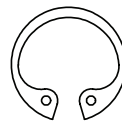

938

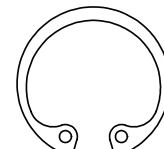

940