

ITEM	QTY.	DESCRIPTION	PART NUMBER					BP	BN	BV	FB	PR	RN	RB	DP
			1 inch	2 inch	3 inch	4 inch	6 inch								
1	1	Washer	4543		4491			X	X	X	X	X	X	X	X
2	1	Thread Seal	4542		4488			X	X	X	X	X	X	X	X
3	1	O-Ring			155			X	X	X	X	X	X	X	X
4	6	Filter Screen			619			X	X	X	X	X	X	X	X
5	1	Pilot Plug	3017		112			X	X	X	X	X	X	X	X
6	1	Gasket Pilot Seat	3018		118			X	X	X	X	X	X	X	X
7	1	Pilot Seat	3016		113			X	X	X	X	X	X	X	X
8	1	Diaphragm Stabilizing	3014		110			X	X	X	X	X	X	X	X
9	1	Pilot Seat	3015		565			X	X	X	X	X	X	X	X
10	1	Spacer Ring	----		7437			X	X	X	X	X	X	X	X
11	1	Diaphragm	3011P		5259P			X	X		X	X	X	X	X
12	1	Spring Helical Conical	3008		108			X		X	X			X	X
	1	Spring	3008		585				X				X		
13	1	Diaphragm Stabilizing	3014		6520									X	
14	1	Gasket Bonnet	4554		276									X	
15	1	Spring Booster (Ductile only)	----		566					X					
16	1	Diaphragm (Ductile only)	3011P		688					X					
17	1	Diaphragm	127	1706	1640	2015	2140	X	X	X	X	X	X	X	X
18	1	Gasket Body	195	196	197	198	199	X	X	X	X	X	X	X	X
19	2	Back Up	148T	149T	150T	151T	152T	X	X		X	X	X	X	X
20	1	O-Ring	153	154	155	156	157	X	X		X	X	X	X	X
21	1	Seat Full Port	163	164	165	166	167	X	X	X	X	X	X	X	X
		Seat Reduced Port	163	164	1230	164	165	X	X	X	X	X	X	X	X
22	1	Gasket Removable Seat	----	276	277	196	279	X	X	X	X	X	X	X	X
23	1	Nut Full Port	172	173	906	175		X	X	X	X	X	X	X	X
		Nut Reduced Port	172	173	173	906		X	X	X	X	X	X	X	X
24	1	O-Ring (Steel only)	----	5225	5226	5227	4086	X	X	X	X	X	X	X	X

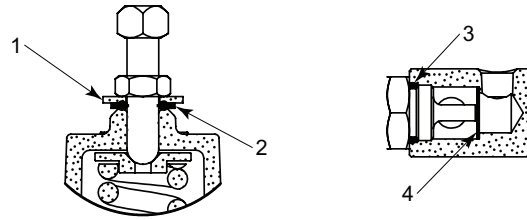

BP, BN, DP

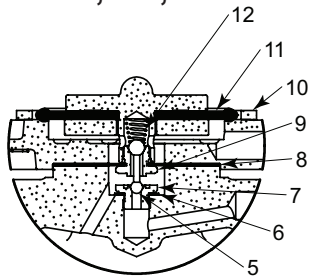

PR, RN, FB

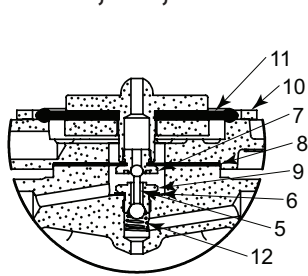

RB

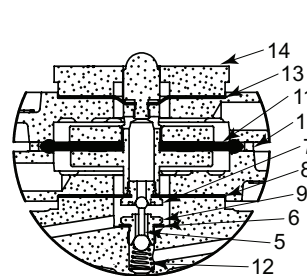

BV

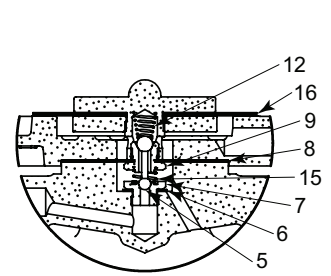

Please note the Pilot Plug (7) and Spring (12) orientation

Ductile

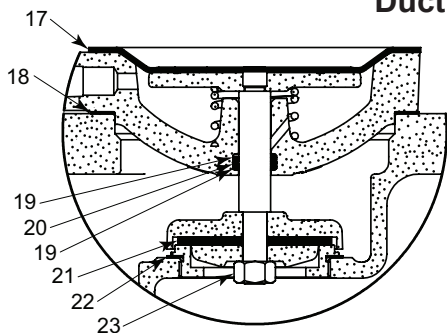

Steel

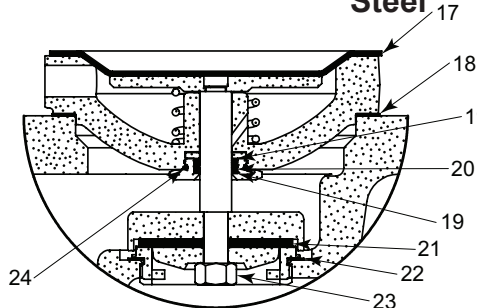

All Pictures shown are for illustration purpose only. Actual product may vary due to product enhancement.

For additional information & documentation visit www.kimray.com

PRESSURE REGULATORS



REPAIR KIT 4 INCH HIGH PRESSURE REGULATORS

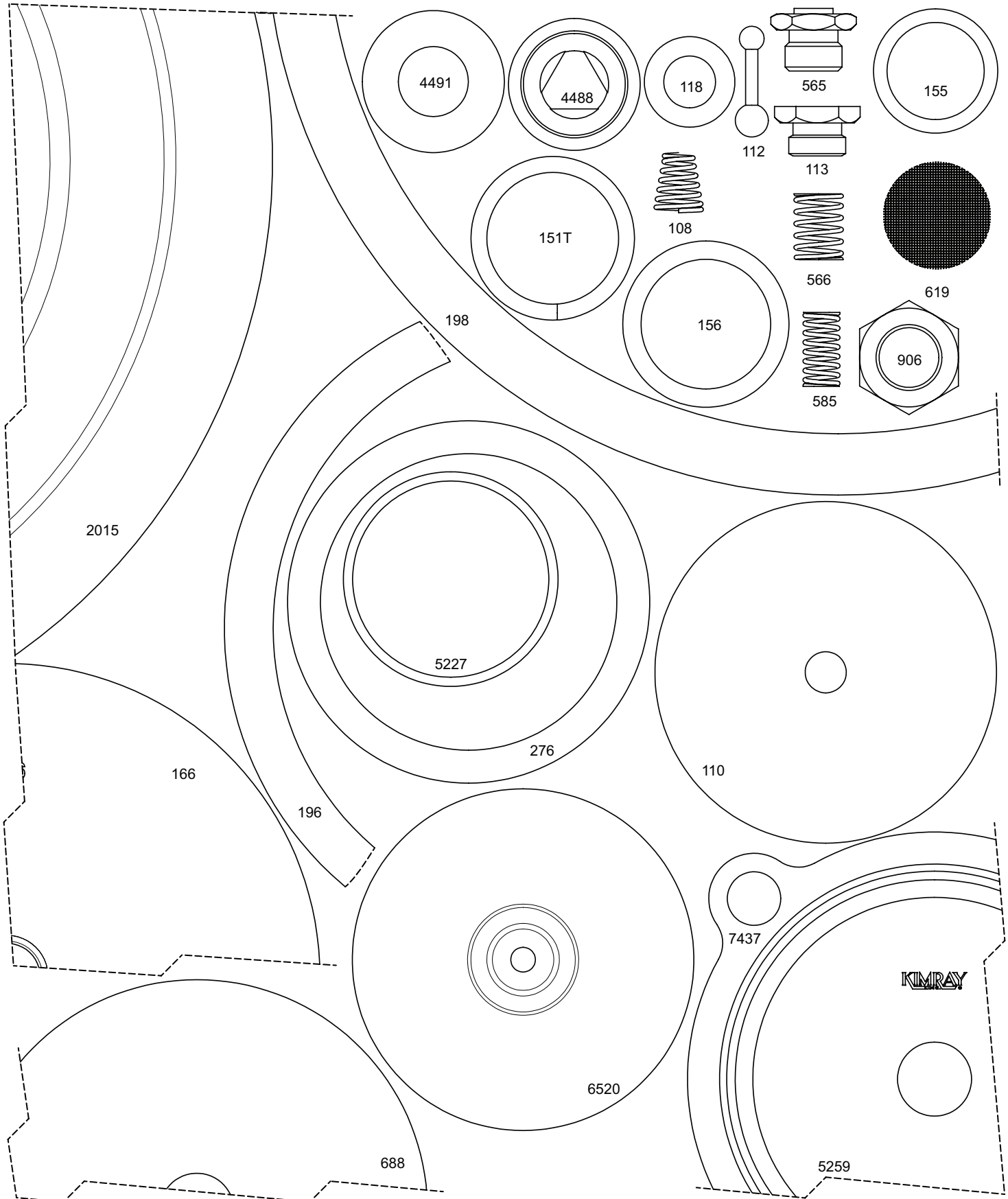

All Pictures shown are for illustration purpose only. Actual product may vary due to product enhancement.